

Recliner

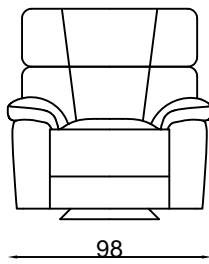

105

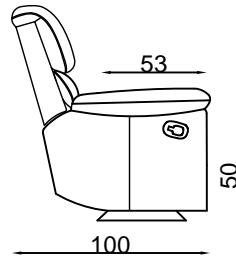

2 (RR)

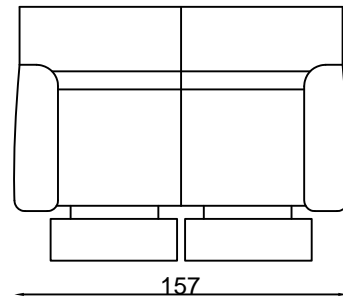

2.5 (RR)

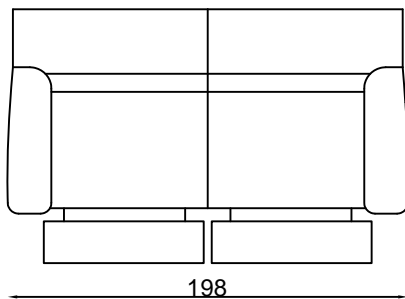

3 (RR)

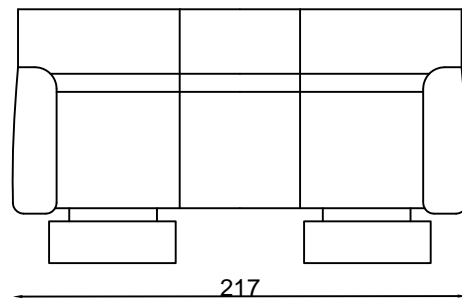

Armchair

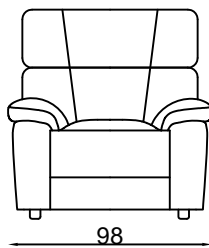

105

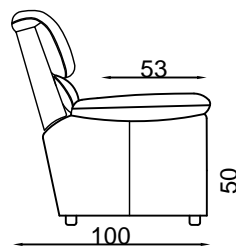

2 seater settee

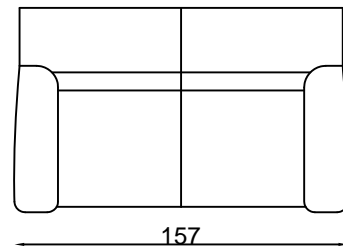

2.5 seater settee

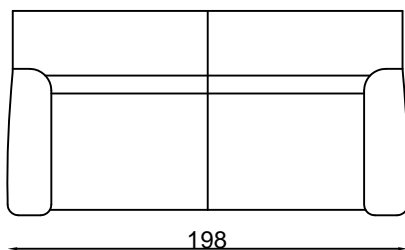

3 seater settee

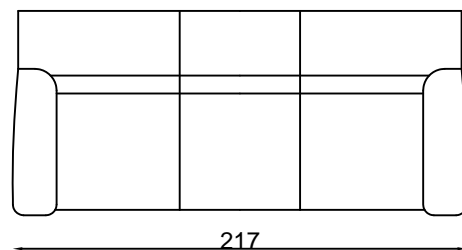

Leg on Fixed chair



Leg on Recliner



Please note lounge is hand made product. This is just indication for measurement. Sometimes our specifications change. Our line drawing includes specifications which are current at the time of printing. However, improvements or alterations to design, construction or techniques or dimensions may occur.