

EHR

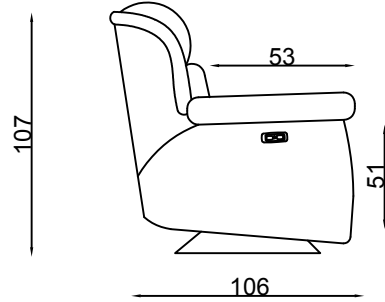

1.5EHR

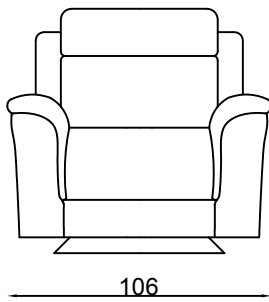
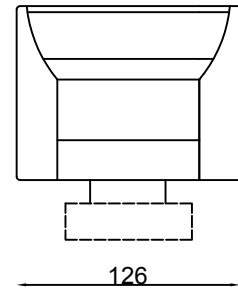

2 (EHREHR)

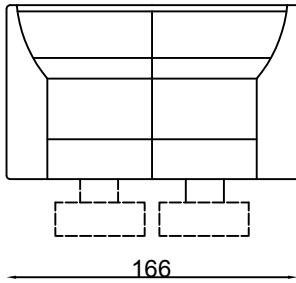

2.5 (EHREHR)

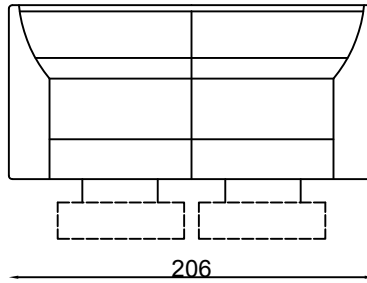

3 (EHREHR)

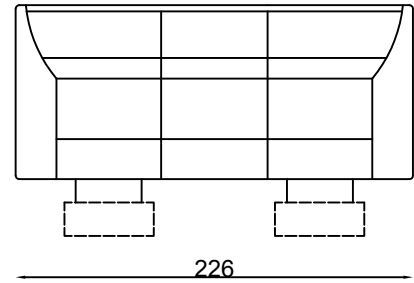

Armchair

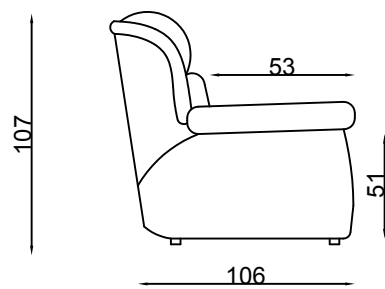
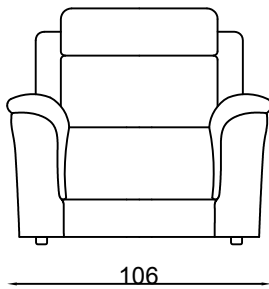

1.5 seater settee

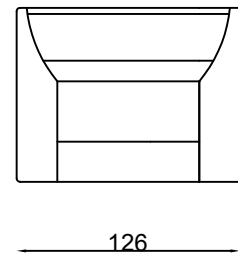

2 seater settee

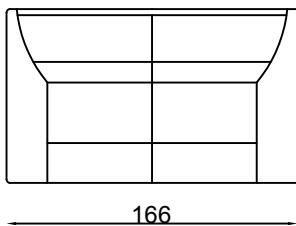

2.5 seater settee

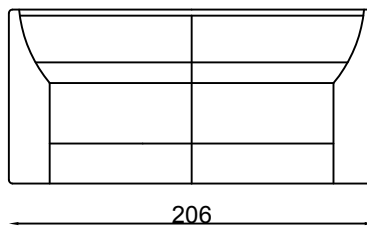

3 seater settee

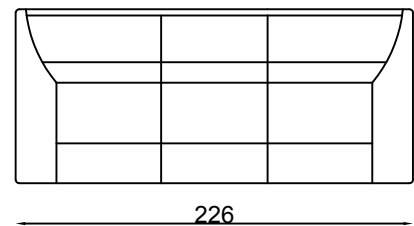

Please note lounge is hand made product. This is just indication for measurement. Sometimes our specifications change. Our line drawing includes specifications which are current at the time of printing. However, improvements or alterations to design, construction or techniques or dimensions may occur.

EHR No arm

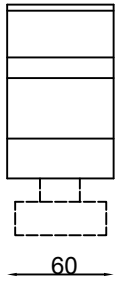

1S No arm

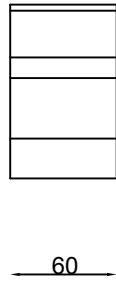

2S No arm

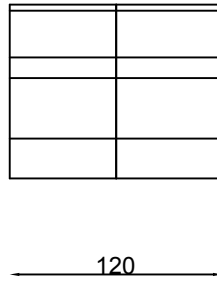

3S No arm

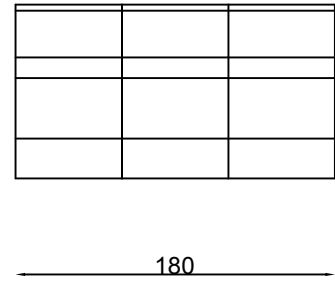

1.5EHR No arm

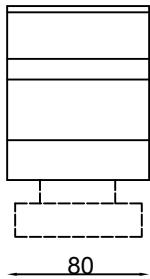

1.5S No arm

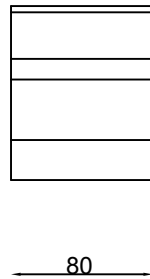

2.5S No arm

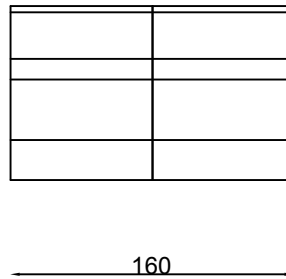

CNR

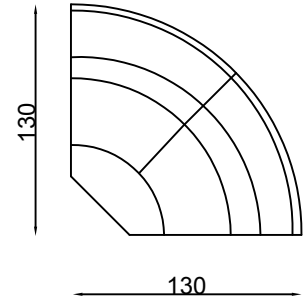

EHR (1arm&LHF)

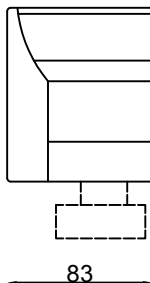

1.5 (EHR) (1arm&LHF)

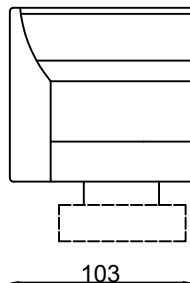

1 (1arm&LHF)

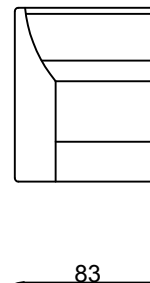

1.5 (1arm&LHF)

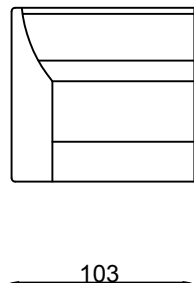

Straight H/T

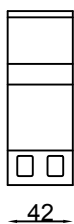

H/T



Leg on Recliner



Leg on Fixed chair



All pieces with 1 arm are available either LHF or RHF

Please note lounge is hand made product. This is just indication for measurement. Sometimes our specifications change. Our line drawing includes specifications which are current at the time of printing. However, improvements or alterations to design, construction or techniques or dimensions may occur.

EHRChaise (RHF)

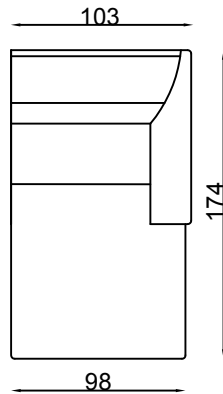

(D1) 1.5 (EHR) (1arm&LHF)-Straight H/T-1.5S
No arm-CNR-2.5 (EHR) (1arm&RHF)

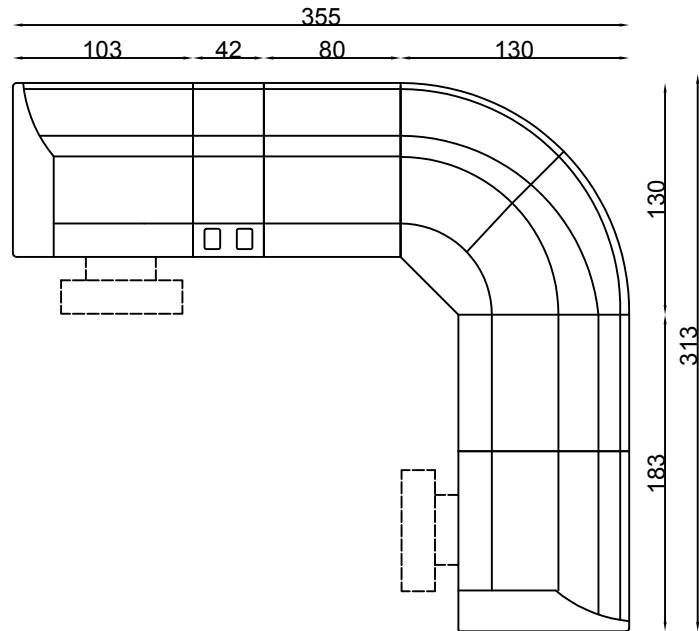

(D2) 2.5 (EHREHR) (1arm&LHF)-EHRChaise (RHF)

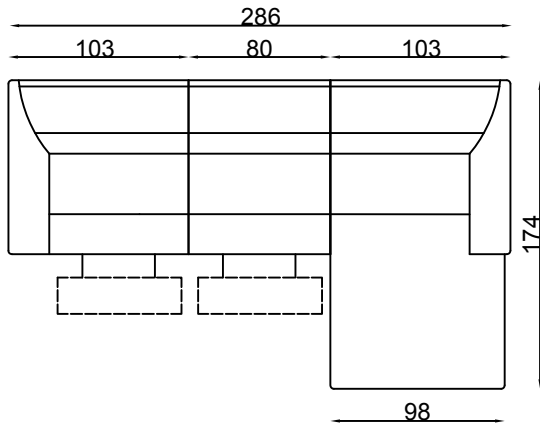

(D3) 2.5 (EHR) (1arm&LHF)-EHRChaise (RHF)

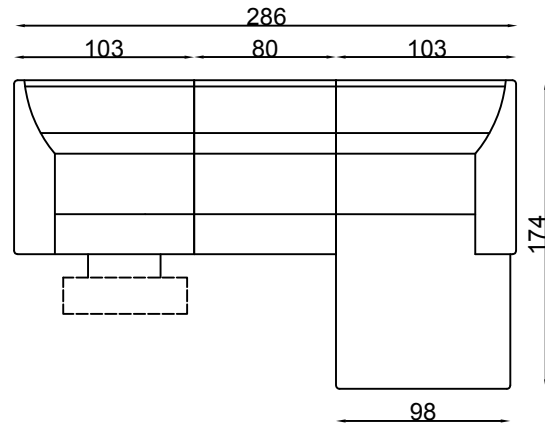

All pieces with 1 arm are available either LHF or RHF

Please note lounge is hand made product. This is just indication for measurement. Sometimes our specifications change. Our line drawing includes specifications which are current at the time of printing. However, improvements or alterations to design, construction or techniques or dimensions may occur.